

Hannah Yan

Email: [hannah@deponpump.com](mailto:hannah@deponpump.com)

Mobile/Skype/WhatsApp: +86 151 0032 3669

# MSP HEAVY DUTY SUMP PUMPS

---



# MSP

## HEAVY DUTY SUMP PUMPS

**Vertical, shaft driven centrifugal slurry pumps.** Rugged pumping solution for the transfer of slurries and large particles from sumps, pits, tanks and other fixed submersible applications.

### HEAVY DUTY SUMP PUMPING

MSP heavy duty sump pumps are vertical, shaft driven centrifugal slurry pumps designed for transferring abrasive and high density slurries from sumps, pits and other submersible sources.

Models are available in sizes ranging from 40mm to 250mm discharge and are capable of flow rates from 5 to 350 litres per second (79-5540 USGPM) at heads of up to 40 metres (130ft). The heavy duty design of the MSP pumps allows the passage of large particles with a diameter of up to 50mm.

Pumps will continue to operate even when the top inlet is not submerged, allowing the liquid level to be lowered to the bottom of the sump or pit. Suction extension pipes of up to 2 metres in length can be added to the bottom inlet of the pump to extend the pumping depth.

Designed as a fixed installation the MSP provides reliable pumping performance with minimal maintenance requirements and simple servicing.

### CANTILEVERED SHAFT

The standard MSP pumps feature a cantilevered shaft which is up to 2400mm long. The cantilevered shaft means that there is no shaft sealing requirement and the drive end bearings do not come into contact with any pumped product. This reduces the risk of bearing failure and extends the wear life of the pumps.

### HEAVY DUTY WET END

Wet end components are manufactured from high quality 27% chrome white iron or rubber coated steel for exceptional wear resistance and service life with minimal corrosion. The heavy duty design can pump high density and abrasive slurries and the large passages of the impeller allows the transfer of large particles without blockages in a wide range of mining, processing and heavy industrial applications.

Wet end stub shaft options are available to suit severe duty applications.

### COLUMN AND DISCHARGE PIPES

Column and discharge pipes are available in a range of materials to suit the requirements of operators. Standard options include mild steel and rubber lined mild steel. Composite options are available.

### VERSATILE DRIVE OPTIONS

MSP pumps can be directly driven using electric motors or belt driven with either set speed or variable speed operation.

### MILESTONE MSP HEAVY DUTY SUMP PUMP





#### REMOVABLE STRAINERS

MSP pumps feature rubber or cast iron upper strainers and cast iron lower strainers to prevent blockages. The strainers are easily removed for servicing or replacement.

#### “L” MODELS EXTENDED SHAFT

The extended shaft “L” model features column bearings and shaft seal which further extends the pumping depth and enables the transfer of slurries from deeper sumps and pits.

#### “L” MODEL WITH EXTENDED SHAFT AND SHAFT SEAL

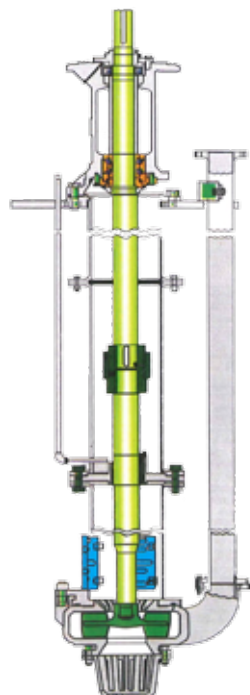

The MSP Heavy Duty Sump Pumps are capable of providing reliable and efficient performance for the transfer of abrasive and high density slurries from sumps, pits and tanks in a wide range of mining, processing and heavy industrial applications.

# TECHNICAL DATA

## SELECTION CHART

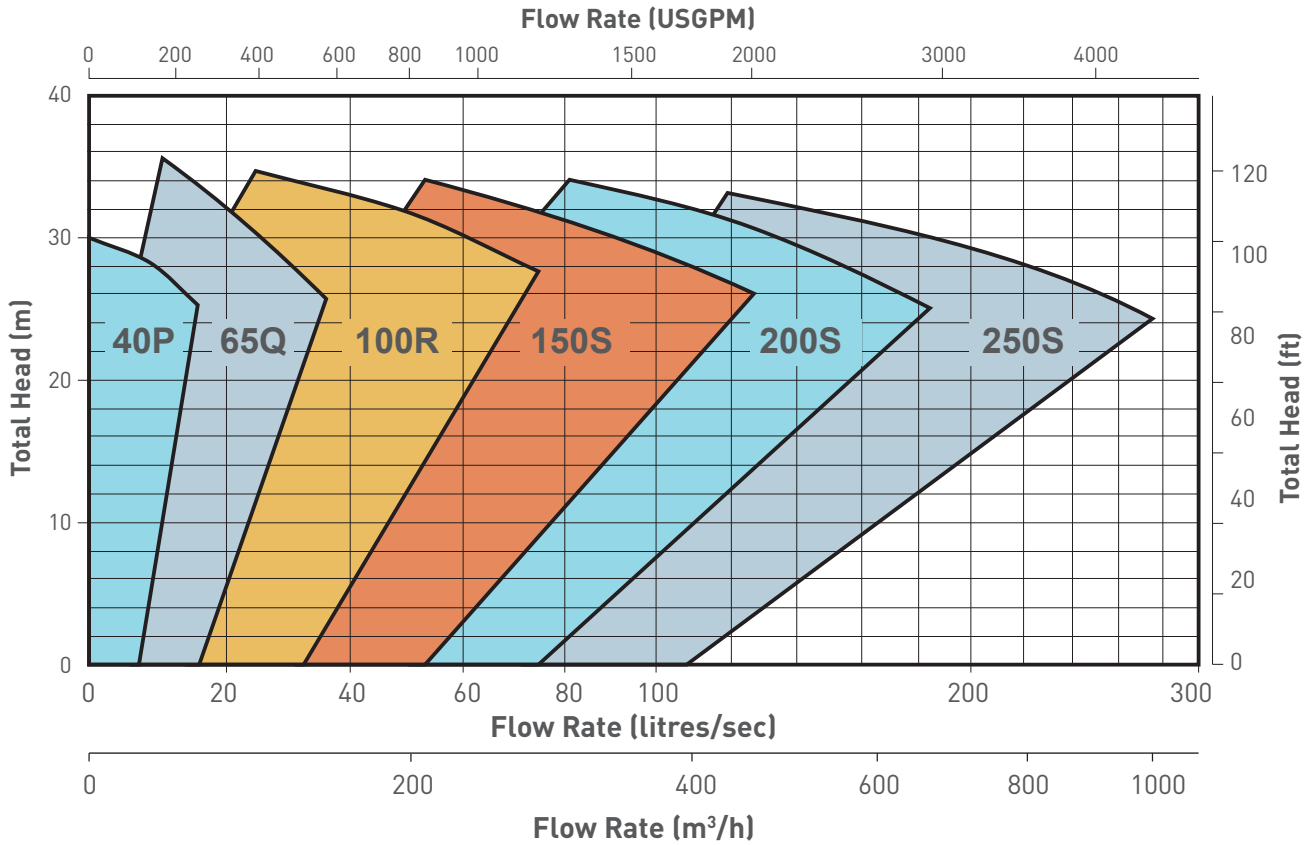

## MATERIALS OF CONSTRUCTION



CANTILEVERED SHAFT

EXTENDED SHAFT

Description	Standard Material	Material Options
Shaft	4140 Mild Steel	Available on Request <sup>1</sup>
Bearing Housing	Cast Iron	
Column	Mild Steel	
Upper Strainer	Rubber	Cast Iron
Lower Strainer	Cast Iron	
Back Liner	27% Chrome White Iron	
Pump Casing	27% Chrome White Iron	Rubber Lined White Iron
Impeller	27% Chrome White Iron	Rubber
Discharge Pipe	Mild Steel	Rubber Lined Mild Steel / Composite
Adaptor Plate	Mild Steel	

<sup>1</sup> installations. Contact us to discuss the availability of material options.

# TECHNICAL DATA

## DIMENSIONS

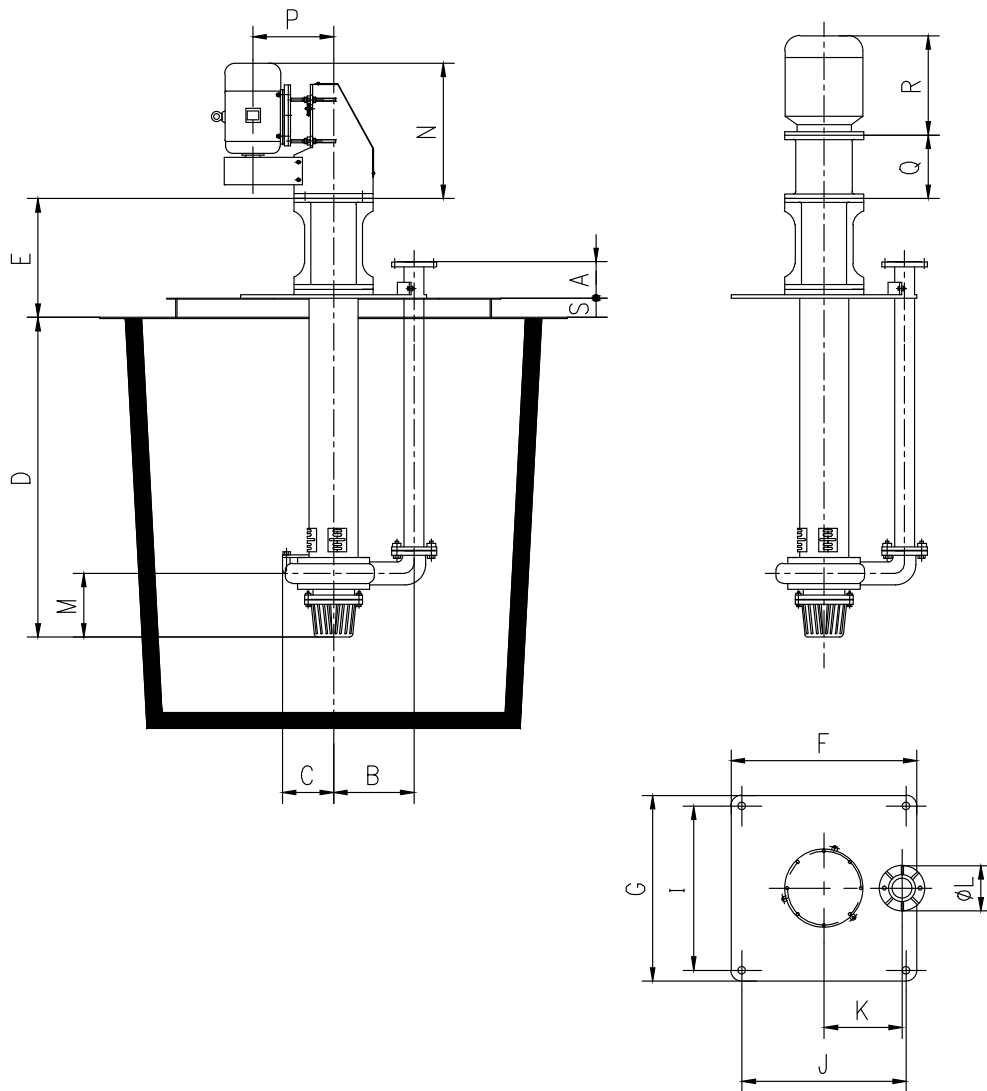

Model	Length (mm)																	
	A	B	C	D	E	F	G	H	J	K	L	M	N	P	Q	R	S	
40P	137	285	153	900*	380	500	500	450	450	205	127	174	733	675	248	629	280	
40PR	140	265	175	1200	380	500	500	450	450	205	127	174	733	675	248	629	280	
65Q	227	399	231	900	492	680	680	620	620	285	178	265	898	794	290	681	350	
65QR	230	380	260	1200*	498	680	680	620	620	285	178	265	898	794	290	681	350	
100R	260	538	317	1200	662	1000	870	800	930	400	229	393	1141	1020	416	960	350	
100RR	266	535	332	1500*	668	1000	870	800	930	400	229	393	1141	1020	416	960	350	
150S	390	670	365	1500	875	1100	1100	1030	1030	500	280	475	1311	1200	476	1011	350	
150SR	395	670	400	1800*	883	1100	1100	1030	1030	500	280	475	1311	1200	476	1011	350	
200S	450	805	440	2100*	878	1300	1200	1100	1200	600	343	550	1313	1300	476	1011	350	
200SR	450	805	440	2400*	878	1300	1200	1100	1200	600	343	550	1313	1300	476	1011	350	
250S	500	930	470	1800	1000	1750	1450	1350	1650	700	406	685	1572	1750	561	1246	400	
250SR	500	930	470	2100*	1000	1750	1450	1350	1650	700	406	685	1572	1750	561	1246	400	

\* Standard length.

# MSP 40PR

## RUBBER LINER AND IMPELLER

### PUMP SPECIFICATIONS

Outlet Dia. (mm)	Bearing Frame	Max Power (kW)	Max Particle Size (mm)	Pumping Depth (mm)	No. of Vanes	Impeller Material	Impeller Dia. (mm)	Wear Liner Material
40	P	15	12	900* 1200	5	Rubber Lined High Tensile Steel	188 - 195	Rubber

\* Standard pumping depth.

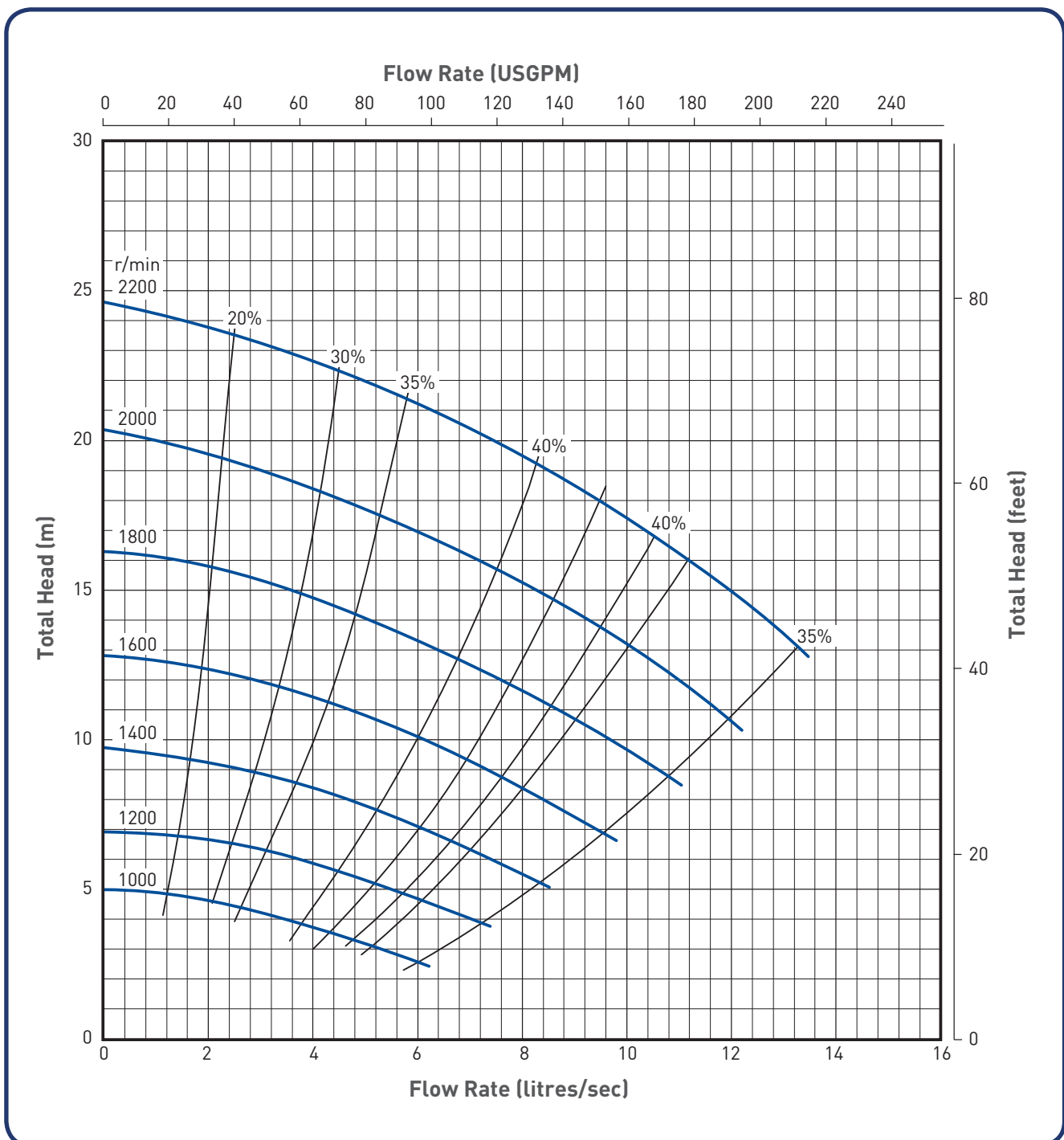

# MSP 40P

## METAL LINER AND IMPELLER

### PUMP SPECIFICATIONS

Outlet Dia. (mm)	Bearing Frame	Max Power (kW)	Max Particle Size (mm)	Pumping Depth (mm)	No. of Vanes	Impeller Material	Impeller Dia. (mm)	Wear Liner Material
40	P	15	12	900* 1200	5	27% Chrome White Iron	188	27% Chrome White Iron

\* Standard pumping depth.

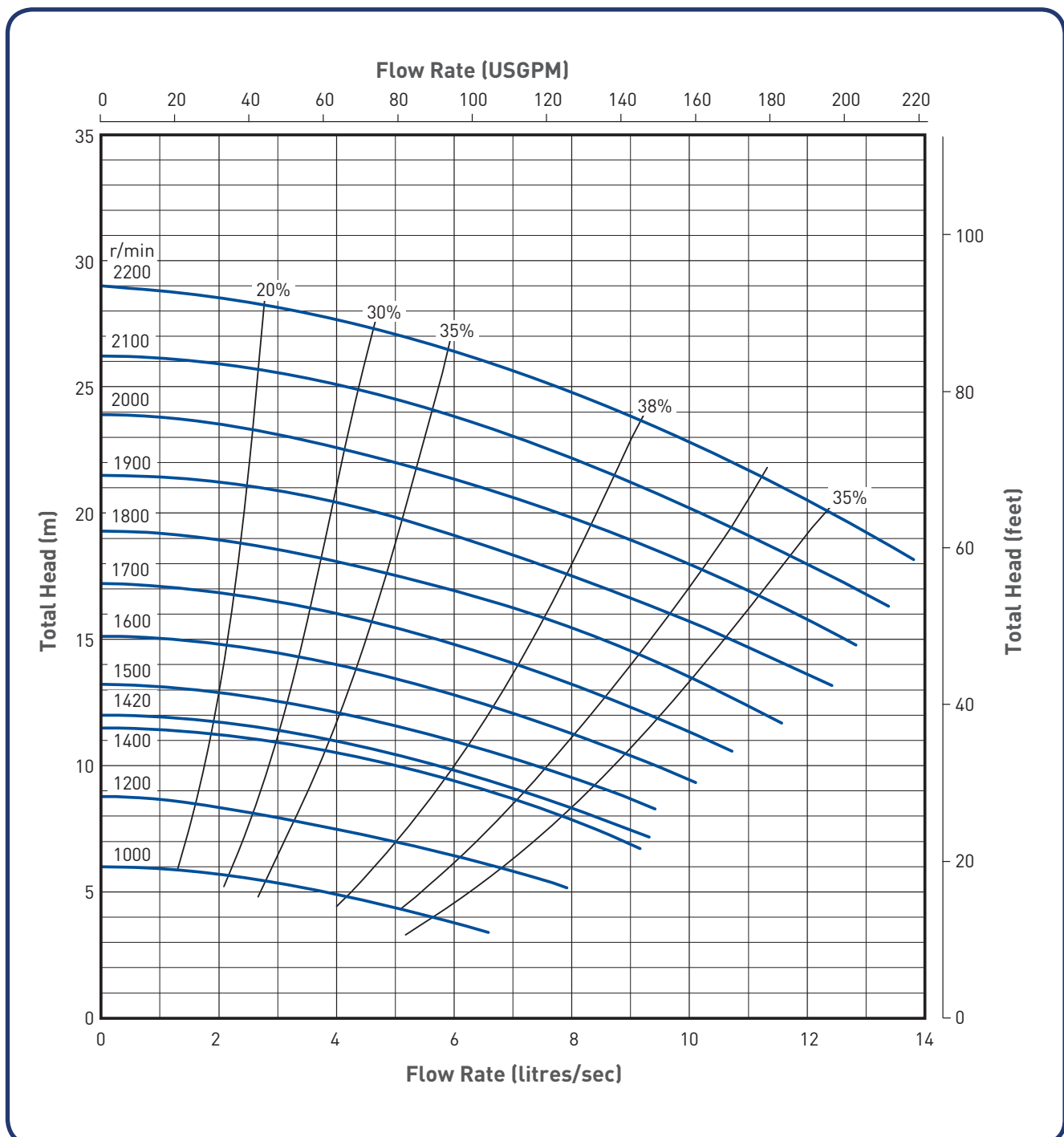

# MSP 65QR

## RUBBER LINER AND IMPELLER

### PUMP SPECIFICATIONS

Outlet Dia. (mm)	Bearing Frame	Max Power (kW)	Max Particle Size (mm)	Pumping Depth (mm)	No. of Vanes	Impeller Material	Impeller Dia. (mm)	Wear Liner Material
65	Q	30	15	900 1200* 1500	5	Rubber Lined High Tensile Steel	280 - 290	Rubber

\* Standard pumping depth.

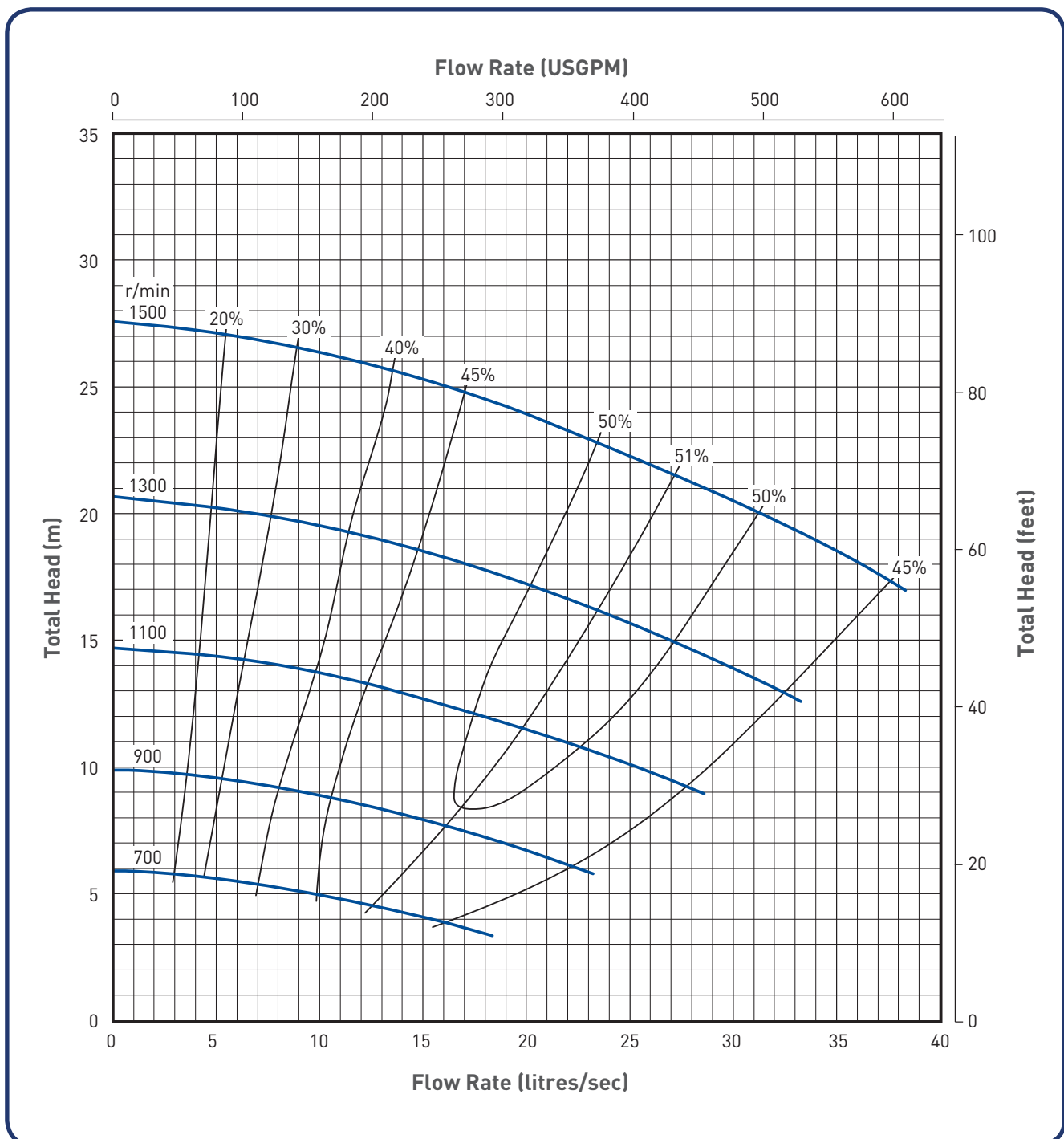

# MSP 65Q

## METAL LINER AND IMPELLER

### PUMP SPECIFICATIONS

Outlet Dia. (mm)	Bearing Frame	Max Power (kW)	Max Particle Size (mm)	Pumping Depth (mm)	No. of Vanes	Impeller Material	Impeller Dia. (mm)	Wear Liner Material
65	Q	30	15	900 1200* 1500	5	27% Chrome White Iron	280	27% Chrome White Iron

\* Standard pumping depth.

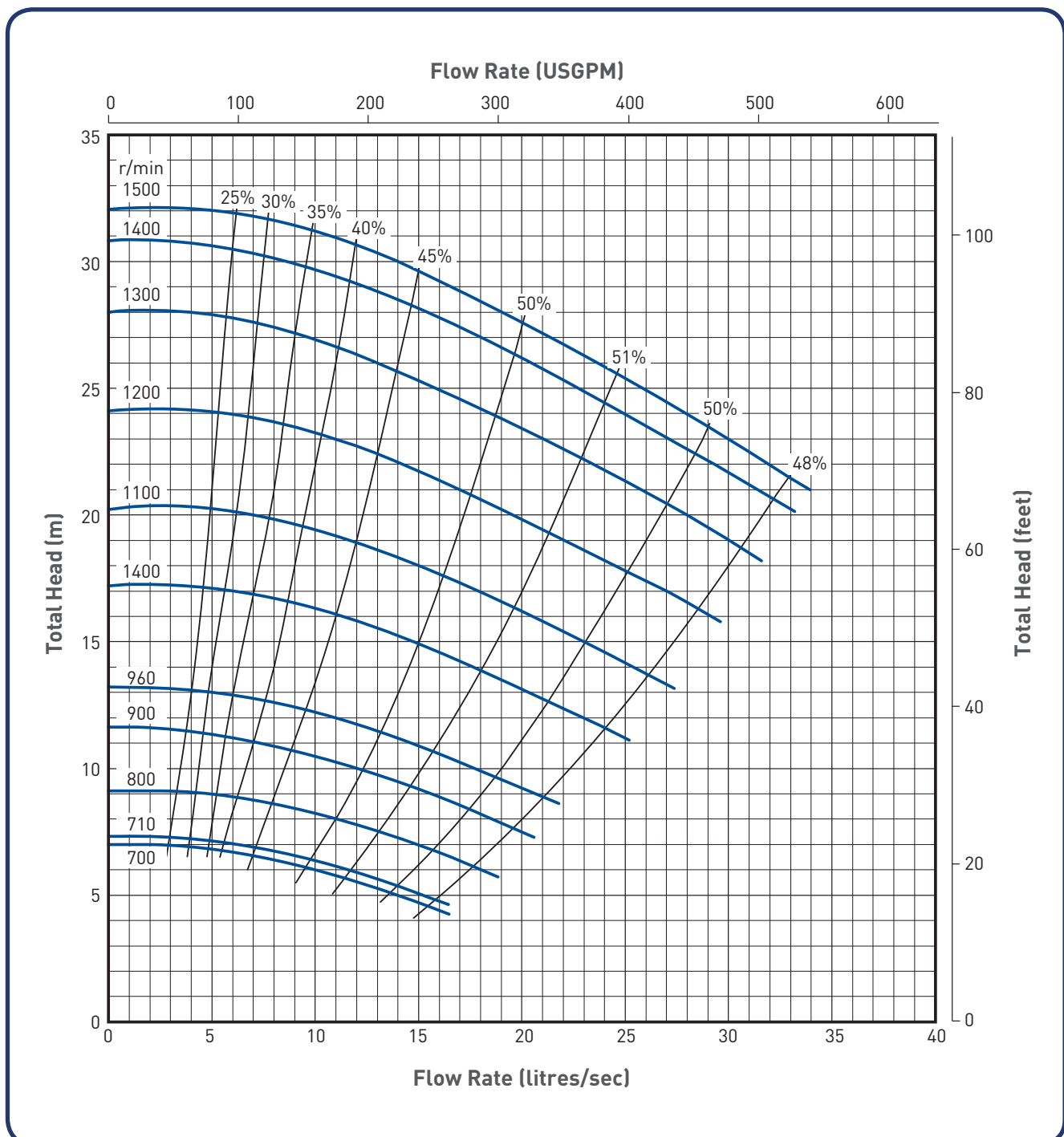

# MSP 100RR

## RUBBER LINER AND IMPELLER

### PUMP SPECIFICATIONS

Outlet Dia. (mm)	Bearing Frame	Max Power (kW)	Max Particle Size (mm)	Pumping Depth (mm)	No. of Vanes	Impeller Material	Impeller Dia. (mm)	Wear Liner Material
100	R	75	40	1200 1500* 2100	5	Rubber Lined High Tensile Steel	370	Rubber

\* Standard pumping depth.

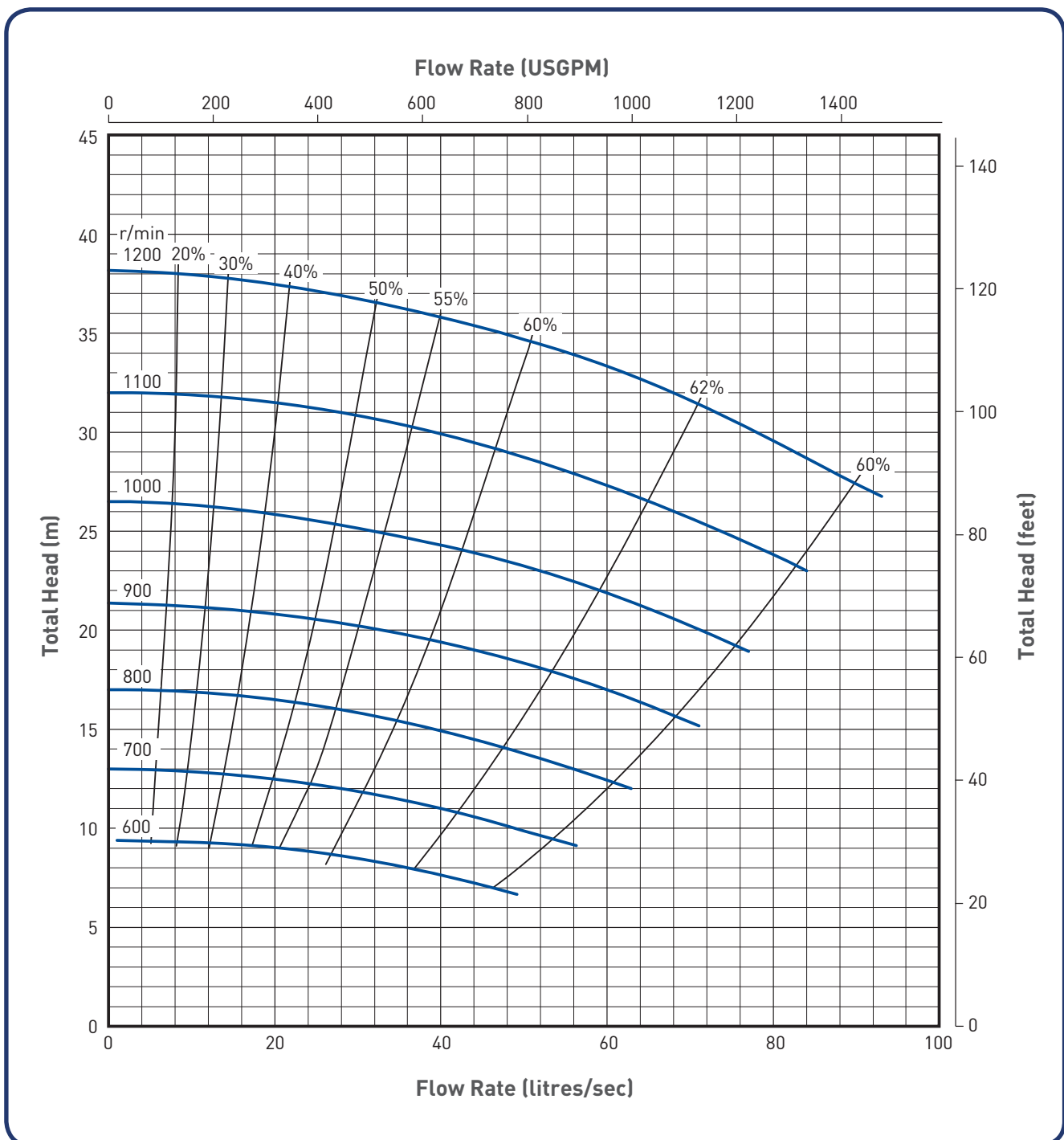

# MSP 100R

## METAL LINER AND IMPELLER

### PUMP SPECIFICATIONS

Outlet Dia. (mm)	Bearing Frame	Max Power (kW)	Max Particle Size (mm)	Pumping Depth (mm)	No. of Vanes	Impeller Material	Impeller Dia. (mm)	Wear Liner Material
100	R	75	32	1200 1500* 2100	5	27% Chrome White Iron	370	27% Chrome White Iron

\* Standard pumping depth.

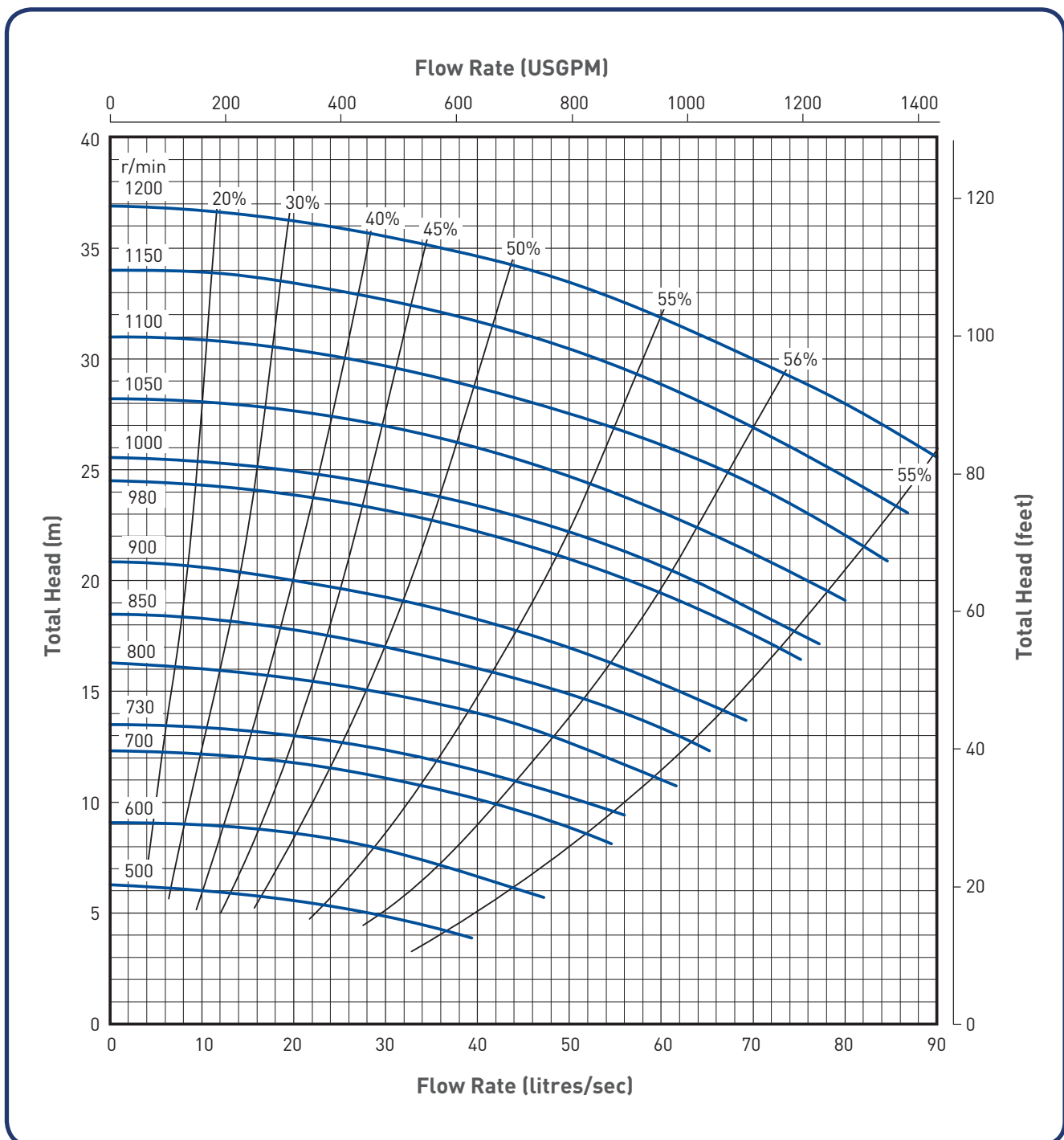

# MSP 150SR

## RUBBER LINER AND IMPELLER

### PUMP SPECIFICATIONS

Outlet Dia. (mm)	Bearing Frame	Max Power (kW)	Max Particle Size (mm)	Pumping Depth (mm)	No. of Vanes	Impeller Material	Impeller Dia. (mm)	Wear Liner Material
150	S	110	45	1500 1800* 2100	5	Rubber Lined High Tensile Steel	450	Rubber

\* Standard pumping depth.

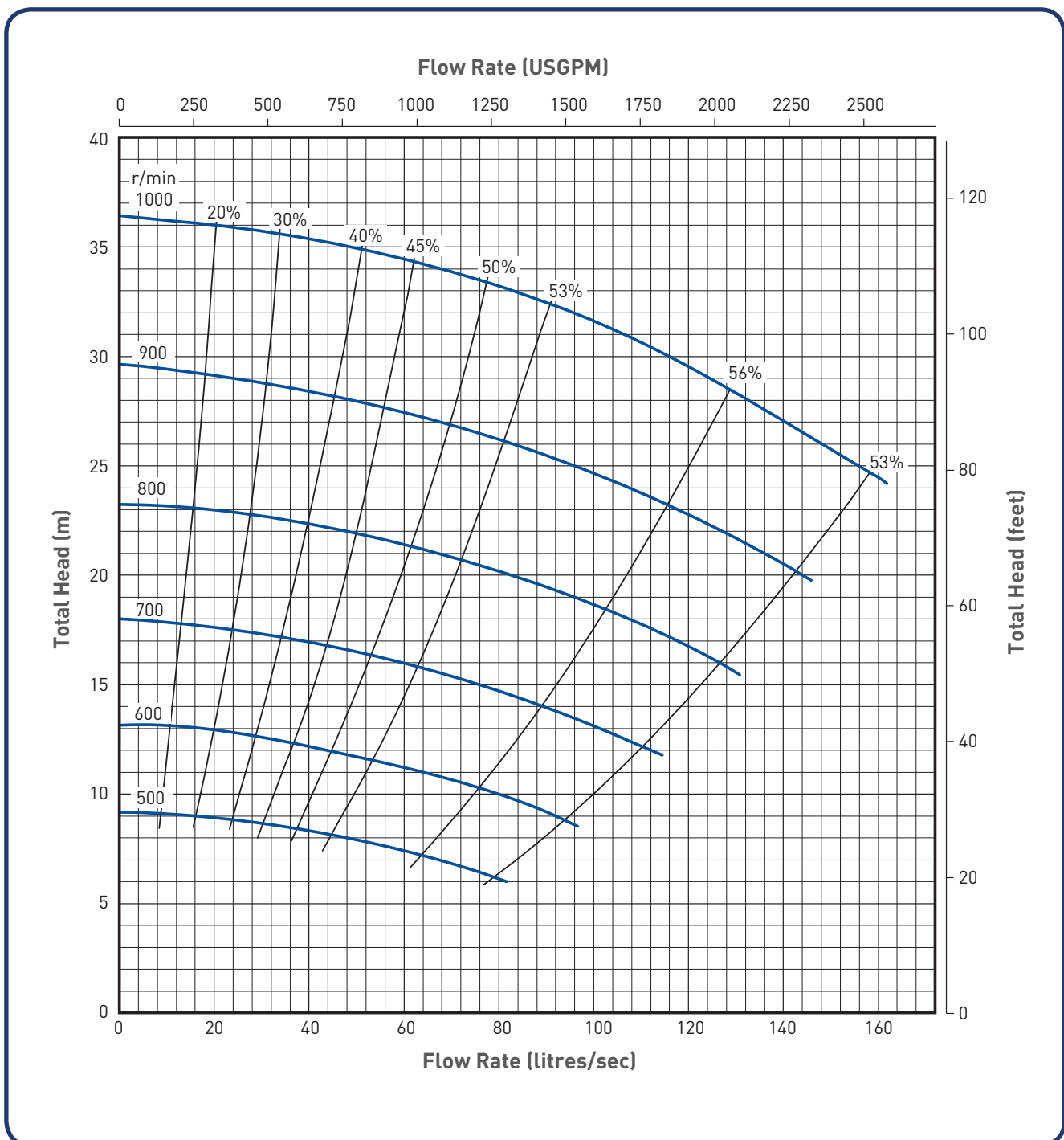

# MSP 150S

## METAL LINER AND IMPELLER

### PUMP SPECIFICATIONS

Outlet Dia. (mm)	Bearing Frame	Max Power (kW)	Max Particle Size (mm)	Pumping Depth (mm)	No. of Vanes	Impeller Material	Impeller Dia. (mm)	Wear Liner Material
150	S	110	45	1500 1800* 2100	5	27% Chrome White Iron	450	27% Chrome White Iron

\* Standard pumping depth.

